

RODOFLEX[®]

#1904



*ACCOUPEMENTS
FLEXIBLES*

FLEXIBLE COUPLINGS

GIUNTI FLESSIBILI

MINIATURE SERIES

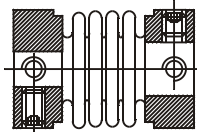
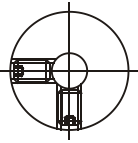

AMK ..

SERIE CON GRANI
SET SCREW HUBS
VIS RADIAUX

gamma tipi fino a coppia nominale
range of sizes up to nominal torque
gamme de tailles jusqu'au couple nominal
max 12 Nm

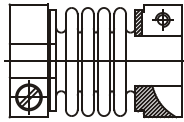

AMKN ..

MOZZI A MORSETTO
SINGLE CLAMP HUBS
MOYEAUX FENDUS, SERRAGE SINGLE

POWER TRANSMISSION SERIES

gamma tipi fino a coppia nominale
range of sizes up to nominal torque
gamme de tailles jusqu'au couple nominal
max 320 Nm

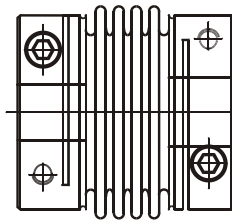
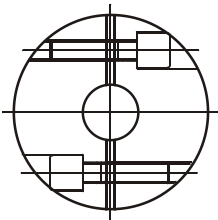

ATMK ..

MOZZI A MORSETTO
DOUBLE CLAMP HUBS
MOYEAUX FENDUS, SERRAGE DOUBLE

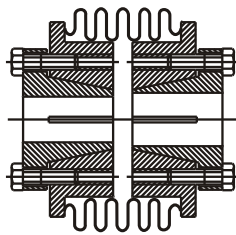
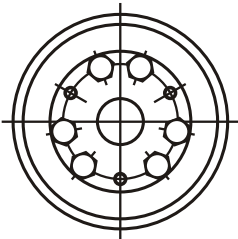

ATMN ..

MOZZI A BOCCOLA CONICA
CONICAL SLEEVE HUBS
MOYEAUX A BAGUE CONIQUE

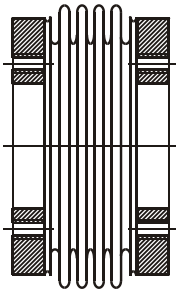
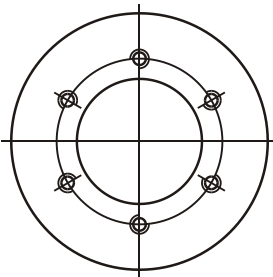

ATMF ..

MOZZI A FLANGIA
FLANGE HUBS
MOYEAUX A FLASQUE

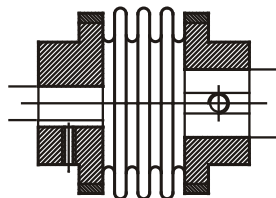
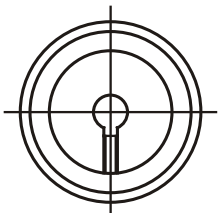

ATMB ..

MOZZI CON CAVA
HUBS WITH KEYWAY DIN 6885 - P9
MOYEAUX AVEC RAINURE

MINIATURE SERIES - ECONOMY

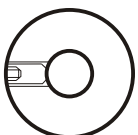

AMKP ..

SERIE CON GRANI
SET SCREW HUBS
VIS RADIAUX

CORPO IN POLIAMMIDE STAMPATO
MOULDED POLYAMIDE BODY
CORPS EN POLYAMIDE

2 taglie, fino a coppia nominale - 2 sizes, up to nominal torque - 2 tailles, jusqu'au couple nominal **max 7 Nm**



INTRODUZIONE

I giunti flessibili **RODOFLEX** a soffietto metallico sono realizzati per accoppiare alberi rotanti, compensando errori di allineamento.

I giunti flessibili **RODOFLEX** sono impiegati in macchine CNC, sia nella rilevazione del moto, sia per la trasmissione di potenza.

L'**elemento flessibile** è un soffietto metallico, che può compensare disallineamenti angolari, paralleli, scostamenti in compressione o allungamento, rimanendo sempre torsionalmente rigido.

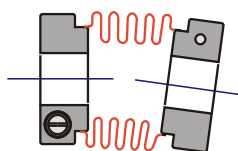

DISALLINEAMENTO ANGOLARE
ANGULAR MISALIGNMENT
MESALIGNEMENT ANGULAIRE

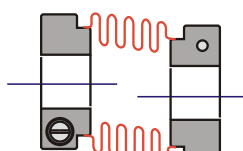

DISALLINEAMENTO PARALLELO
PARALLEL MISALIGNMENT
MESALIGNEMENT LATERAL

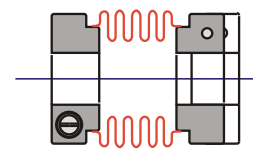

SCOSTAMENTO ASSIALE
AXIAL DISPLACEMENT
DEPLACEMENT AXIAL

La **rigidità torsionale** è la caratteristica più importante dei giunti flessibili **RODOFLEX**; non vi sono giochi, elasticità radiali o errori nella trasmissione del movimento.

Grazie al soffietto metallico la costruzione è compatta e leggera, con un rapporto favorevole massa/coppia e quindi un **momento d'inerzia limitato**, ideale nelle applicazioni con forti accelerazioni, alte velocità ed inversioni del senso di rotazione.

Oltre alla produzione standard, presentata su questo catalogo, è possibile produrre versioni speciali su disegno del Cliente.

INTRODUCTION

RODOFLEX flexible couplings are designed to connect rotating shafts and to compensate alignment errors.

RODOFLEX flexible couplings are used in CNC machine tools, both for coupling motion controlled devices and for effective power transmission.

The couplings's **flexible element** is the metallic bellows which can tolerate angular and parallel misalignment, compression and traction, while remaining torsionally stiff.

The **torsional stiffness** is the most important feature of the **RODOFLEX** flexible couplings; there are no clearance, back-lash or position transmission errors.

The metallic bellows being the flexible element, the construction is compact and lightweight. It has a good mass/torque ratio and therefore a **limited moment of inertia**, which is useful in applications with high acceleration, rotation sense reversal and high rotation speed.

Beside the standard production range presented in this catalogue, manufacturing of special units may be accomplished.

INTRODUCTION

Les accouplements **RODOFLEX** sont utilisés pour la connection des arbres en rotation en absorbant les défauts d'alignement.

Les accouplements **RODOFLEX** sont utilisés dans les machines à CNC, soit pour la transmission des angles de rotation pour les codeurs, soit pour la transmission de puissance.

L'**élément flexible** est un soufflet métallique qui accepte les erreurs d'alignement angulaires, parallèles, la dérivation de la longueur et en même temps reste rigide à la torsion.

La **rigidité torsionelle** est la caractéristique la plus importante des accouplements **RODOFLEX**; il n'y a pas de jeux ou élasticité radials et erreurs de transmission.

La légèreté du soufflet et la construction compacte sont importants pour un rapport masse/couple favorable et donc il y a un **moment d'inertie limité**. Cela est un grand avantage dans les applications avec hautes accélérations, inversion du sens et hautes vitesse de rotation.

Au-delà de la production standard présentée dans le catalogue, il est possible de réaliser des versions spéciales sur commande.

SERIE DI PRODUZIONE

Il programma di produzione è diversificato per disporre di componenti ottimizzati per i casi di applicazioni più diversi.

I diversi sistemi di bloccaggio sono adeguati al massimo momento torcente indicato e sono tutti egualmente affidabili.

La scelta del tipo deve avvenire considerando:

- 1 - coppia torcente
- 2 - entità dei disallineamenti
- 3 - dimensioni dell'ingombro
- 4 - comodità di serraggio

● MINIATURA

Giunti per accoppiamento encoder e dinamo tachimetriche o azionamenti leggeri fino a 12 Nm nominali.

Soffietto in lega rame-zinco CuZn20, mozzi in lega leggera AlCuMgPb.
Utilizzabili fino a +80°C

- serie **AMK..** con fissaggio alberi tramite due grani filettati radiali.

- serie **AMKN..** con fissaggio a morsetto singolo.

MANUFACTURING PROGRAMME

Manufacturing series with different features are available to meet requirements in a wide range of application cases.

The various clamping systems are suited for the maximum rotation torque and they are equally reliable. The choice among the coupling types should be made in consideration of:

- 1 - torque value
- 2 - misalignment figures
- 3 - overall dimensions
- 4 - access for mounting/tightening

● MINIATURE

Small couplings for resolvers and encoder devices and light drives up to 12 Nm nominal torque.

Bellows made of copper-zinc alloy CuZn20, hubs of light alloy AlCuMgPb.
They can be used at temperatures up to +80°C

- **AMK..** series, two radial grub-screws on each hub for tightening.

- **AMKN..** series, single shaft clamping device.

PROGRAMME DE PRODUCTION

Le programme de production est bien structuré à fin d'obtenir la solution optimale pour chaque cas d'application.

Les systèmes de blocage sont tous proportionnés au moment de torsion maximum prévu, ils sont tous également fiables.

Pour le choix du type il faut tenir compte de:

- 1 - couple de torsion
- 2 - valeurs des mesalignements
- 3 - dimensions d'encombrement
- 4 - facilité de serrage

● MINIATURE

Accouplements pour résolveurs, codeurs et entraînement légers jusqu'à 12 Nm couple nominal.

Soufflet en alliage cuivre-zinc CuZn20, moyeux en alliage légers AlCuMgPb.
Utilisables jusqu'à +80°C.

- séries **AMK..** blocages des arbres par deux vis radiales par moyeu

- séries **AMKN..** système de blocage unique par moyeux fendus.



AMK ..

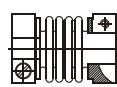

AMKN ..

● TRASMISSIONE DI POTENZA

Giunti per azionamenti di potenza fino a 320 Nm.

Soffietto in acciaio inossidabile 1.4541, saldato per l'intera circonferenza ai mozzi in acciaio inossidabile 1.7227.

Utilizzabili fino a +300°C.

- serie **ATMN..** con boccia conica

- serie **ATMK..** con morsetto doppio (singolo taglia <20)

- serie **ATMB..** con cava per chiavetta

- serie **ATMF..** con mozzo a flangia.

● POWER TRANSMISSION

Couplings for power drive, up to 320 Nm.

Bellows made of stainless steel 1.4541, stainless steel 1.7227 hubs, welded to bellows on their whole crown. They can be used at temperatures up to +300°C.

- **ATMN..** series, conical sleeve hubs

- **ATMK..** series, double clamp hubs (single size <20)

- **ATMB..** series, hubs with keyway

- **ATMF..** series, flange hubs

● TRANSMISSION de PUISSANCE

Accouplements pour la transmission de puissance jusqu'à 320 Nm.

Soufflet en acier inoxydable 1.4541, soudé sur toute la circonférence aux moyeux en acier inoxydable 1.7227. Utilisables jusqu'à +300°C.

- série **ATMN..** à bague conique

- série **ATMK..** moyeux fendus doubles (single taille <20)

- série **ATMB..** moyeux avec rainure

- série **ATMF..** moyeux à flasque

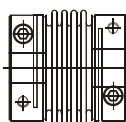

ATMK ..

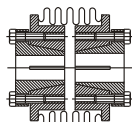

ATMN ..

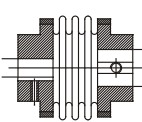

ATMB ..

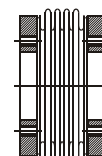
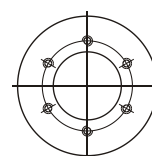

ATMF ..

CARATTERISTICHE GENERALI

CAMPO DI FORATURA MOZZI

In giunti **RODOFLEX** a soffietto metallico sono forniti con fori finiti, nel diametro richiesto, in tolleranza G7.

Possono essere ordinati con combinazione di diametri standard, come indicato nelle relative tabelle. Diametri non rientranti negli standard possono essere forniti a richiesta.

I giunti in miniatura in poliammide tipi **AMKP..** (pag. 16) sono forniti con fori grezzi, alesabili a cura dell'utilizzatore.

VELOCITA' DI ROTAZIONE

Sia i tipi in miniatura **AMK..** e **AMKN..**, sia i tipi per la trasmissione di potenza **ATMN**, **ATMK**, **ATMB** e **ATMF** sono garantiti per impieghi fino a 6.000 giri/min'.

Per velocità di rotazione più alte, verificare i parametri dell'applicazione con il costruttore. E' possibile fornire giunti equilibrati all'origine.

FATTORE DI SICUREZZA

Nel calcolo dei dati delle prestazioni è stato considerato il **fattore di sicurezza 2,5**.

In previsione di forti accelerazioni e decelerazioni, inversioni di rotazione, disallineamenti massimi ed alte velocità di rotazione, la coppia torcente di picco può superare del 100% il momento di rotazione nominale indicato a catalogo.

MANUTENZIONE E DURATA

I giunti **RODOFLEX** non richiedono alcuna manutenzione; se impiegati nel rispetto dei parametri indicati, la loro durata è praticamente infinita.

SERIE SPECIALI

Oltre alla produzione standard, possono essere realizzati giunti secondo requisiti particolari, quali maggiore lunghezza, maggior flessibilità e forature speciali.

GENERAL FEATURES

HUB'S BORE RANGE

RODOFLEX metal bellows couplings are supplied with hubs bored at diameter required, machined at tolerance G7.

They may be ordered with combination of standard diameters, as stated in the relevant tables. Non-standard bores may be available on demand

Miniature polyamide couplings **AMKP..** types (page 16) are supplied with coarse hubs that can be drilled by users.

ROTATION SPEED

Miniature types **AMK..** and **AMKN..** as well as power transmission types **ATMN**, **ATMK**, **ATMB** and **ATMF** can be used up to 6,000 rpm.

For higher rotation speed, check application details with supplier.

Couplings may be extra balanced in our factory on demand.

SECURITY FACTOR

Maximum torque and misalignment figures are stated in consideration of **security factor 2.5**.

In presence of high acceleration and deceleration rates, high misalignment, rotation reversal and high rotation speed, the peak torque can be 100% higher than the nominal torque stated in the catalogue.

MAINTENANCE AND LIFE SPAN

RODOFLEX do not require maintenance; if they are employed in respect of the given application parameters, their life span is in practice endless.

SPECIAL SERIES

Couplings with special features may be manufactured beside the standard production programme. Variations may concern greater length, more flexibility or special hub bore diameters.

CARACTERISTIQUES GENERAUX

ALESAGE DES MOYEUX

Les accouplements **RODOFLEX** à soufflet métallique sont livrés avec les alésages des moyeux finis au diamètre demandé, tolérance G7. Ils peuvent être commandés avec combinaison d'alésages standard, dans les diamètres indiqués dans les tableaux relatifs.

Les accouplements miniature en polyamide types **AMKP..** (page 16) sont livrés pré-forés et peuvent être alésés par l'utilisateur.

VITESSE DE ROTATION

Les types **AMK..** et **AMKN..**, soit les types transmission de puissance **ATMN**, **ATMK**, **ATMB** et **ATMF** sont garantis pour l'emploi jusqu'à 6.000 tour/min'.

Pour des vitesses de rotation plus hautes, il faut vérifier les paramètres d'application avec le fournisseur.

Il est possible de livrer des accouplements équilibrés à l'usine.

FACTEUR DE SECURITE'

Le **facteur de sécurité 2,5** est considéré dans les calculs des performances.

Pour des hautes accélérations et décélérations, inversion de rotation, grandes mesalignements et hautes vitesse de rotation, la pointe de couple de torsion peut dépasser du 100% le couple nominal indiqué dans le catalogue.

ENTRETIEN ET DUREE

Les accouplements **RODOFLEX** n'ont pas besoin d'entretien s'ils sont employés respectant les paramètres donnés, leur durée d'utilisation est pratiquement infinie.

SERIES SPECIALES

Des accouplements spéciaux sont produits suivant des exigences spéciales comme longueur majeur, flexibilité plus haute et alésages spéciaux.

RODOFLEX

FLEXIBLE COUPLINGS - TORSIONALLY STIFF

GIUNTO FLESSIBILE
TORSIONALMENTE RIGIDI
PER ENCODER

FLEXIBLE COUPLINGS
TORSIONALLY STIFF
FOR ENCODERS

JOINT D'ACCOUPEMENT
RIGIDITE A LA TORSION
POUR CODEURS

AMK..

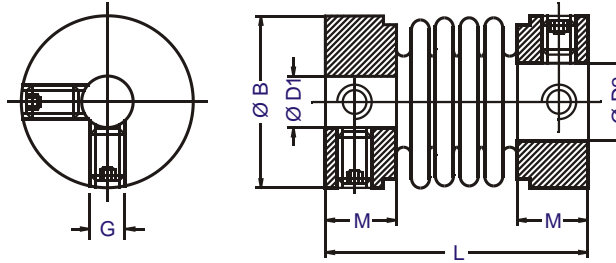

TIPO TYPE TYPE	Ø D ¹ - D ² MIN MAX mm	Ø B mm	L mm	M mm	G
AMK 0 .. L15	1 => 4	10,5	15	6,5	M3
AMK 1 .. L21	2 => 6,35	12,7	21	6,0	M3
AMK 1 .. L26	2 => 6,35	12,7	26	6,0	M3
AMK 1,2 .. L24	2 => 8	14,5	24	7,5	M4
AMK 1,2 .. L29	2 => 8	14,5	29	7,5	M4
AMK 2 .. L26	2 => 6,35	12,7	26	6,0	M3
AMK 2,2 .. L29	2 => 8	14,5	29	7,5	M4
AMK 2,3 .. L31	5 => 12	20,0	31	9,5	M4
AMK 3 .. L32	3 => 14	24,0	32	12,5	M6
AMK 3 .. L41	3 => 14	24,0	41	12,5	M6
AMK 4 .. L41	3 => 14	24,0	41	12,5	M6
AMK 4,5 .. L34	5 => 20	30,0	34	12,0	M6
AMK 4,5 .. L40	5 => 20	30,0	40	12,0	M6
AMK 5 .. L54	5 => 24	39,5	54	16,5	M8
AMK 5 .. L61	5 => 24	39,5	61	16,5	M8
AMK 6 .. L54	5 => 24	39,5	54	16,5	M8
AMK 6 .. L61	5 => 24	39,5	61	16,5	M8

Ø FORI STANDARD

Ø ALESAGES STANDARD

STANDARD Ø BORES

TIPO/TYP	1	1,6	2	3	3,2 1/8"	4	5	6	6,35 1/4"	7	8	9	9,52 3/8"	10	11	12	12,7 1/2"	14	
AMK 0 .. L15	1	1,6	2	3	3,2	4													
AMK 1 .. L21			2	3	3,2	4	5	6	6,35										
AMK 1 .. L26			2	3	3,2	4	5	6	6,35										
AMK 1,2 .. L24			2	3	3,2	4	5	6	6,35	7	8								
AMK 1,2 .. L29			2	3	3,2	4	5	6	6,35	7	8								
AMK 2 .. L26			2	3	3,2	4	5	6	6,35										
AMK 2,2 .. L29			2	3	3,2	4	5	6	6,35	7	8								
AMK 2,3 .. L31							5	6	6,35	7	8	9	9,52	10	11	12			
AMK 3 .. L32				3	3,2	4	5	6	6,35	7	8	9	9,52	10	11	12	12,7	14	
AMK 3 .. L41				3	3,2	4	5	6	6,35	7	8	9	9,52	10	11	12	12,7	14	
AMK 4 .. L41				3	3,2	4	5	6	6,35	7	8	9	9,52	10	11	12	12,7	14	
TIPO/TYP	5	6	6,35 1/4"	7	8	9	9,52 3/8"	10	11	12	12,7 1/2"	14	15	16	18	19	20	22	24
AMK 4,5 .. L34	5	6	6,35	7	8	9	9,52	10	11	12	12,7	14	15	16	18		20		
AMK 4,5 .. L40	5	6	6,35	7	8	9	9,52	10	11	12	12,7	14	15	16	18		20		
AMK 5 .. L54	5	6	6,35	7	8	9	9,52	10	11	12	12,7	14	15	16	18	19	20	22	24
AMK 5 .. L61	5	6	6,35	7	8	9	9,52	10	11	12	12,7	14	15	16	18	19	20	22	24
AMK 6 .. L54	5	6	6,35	7	8	9	9,52	10	11	12	12,7	14	15	16	18	19	20	22	24
AMK 6 .. L61	5	6	6,35	7	8	9	9,52	10	11	12	12,7	14	15	16	18	19	20	22	24

GIUNTO FLESSIBILE TORSIONALMENTE RIGIDI PER ENCODER

- ① COPPIA NOMINALE
- ② DISALLINEAMENTO PARALLELO
- ③ DISALLINEAMENTO IN DISTANZA
- ④ DISALLINEAMENTO ANGOLARE
- ⑤ RIGIDITA' TORSIONALE
- ⑥ MOMENTO D'INERZIA
- ⑦ MOMENTO SERRAGGIO VITI

FLEXIBLE COUPLINGS TORSIONALLY STIFF FOR ENCODERS

- ① NOMINAL TORQUE
- ② PARALLEL MISALIGNMENT
- ③ AXIAL DISPLACEMENT
- ④ ANGULAR MISALIGNMENT
- ⑤ TORSIONAL STIFFNESS
- ⑥ MOMENT OF INERTIA
- ⑦ SCREW TIGHTENING TORQUE

JOINT D'ACCOUPEMENT RIGIDITE A LA TORSION POUR CODEURS

- ① COUPLE NOMINAL
- ② MESALIGNEMENT PARALLEL
- ③ DEPLACEMENT AXIAL
- ④ MESALIGNEMENT ANGULAIRE
- ⑤ RIGIDITE' EN TORSION
- ⑥ MOMENT D'INERTIE
- ⑦ MOMENT SERRAGE DES VIS

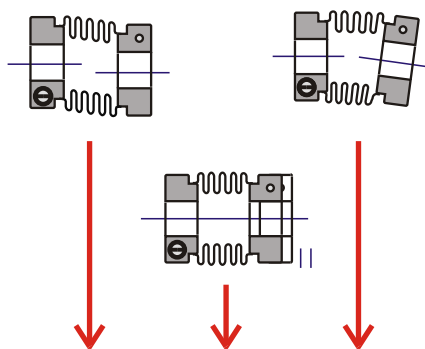

TIPO TYPE TYPE	① Nm	② PARALL. mm	③ DIST. mm	④ ANG. α°	⑤ Nm/rad	⑥ gcm ²	⑦ g
AMK 0 .. L15	0,25	0,07	0,15	0,5°	96	1,0	4
AMK 1 .. L21	0,40	0,10	0,25	1,5°	122	2,0	4
AMK 1 .. L26	0,40	0,10	0,25	1,5°	122	2,0	6
AMK 1,2 .. L24	0,40	0,10	0,25	1,5°	122	2,0	8
AMK 1,2 .. L29	0,40	0,10	0,25	1,5°	122	2,0	8
AMK 2 .. L26	0,90	0,10	0,25	0,5°	285	4,0	10
AMK 2,2 .. L29	0,90	0,10	0,25	0,5°	285	4,0	12
AMK 2,3 .. L31	1,10	0,10	0,25	1,0°	257	7,0	16
AMK 3 .. L32	2,00	0,15	0,30	1,0°	615	25,0	26
AMK 3 .. L41	2,00	0,15	0,30	1,0°	615	25,0	26
AMK 4 .. L41	4,00	0,10	0,30	1,0°	1170	36,0	38
AMK 4,5 .. L34	3,00	0,20	0,40	1,0°	980	49,0	30
AMK 4,5 .. L40	3,00	0,20	0,40	1,0°	980	49,0	30
AMK 5 .. L54	7,00	0,25	0,60	2,0°	2910	272,0	100
AMK 5 .. L61	7,00	0,25	0,60	2,0°	2910	272,0	100
AMK 6 .. L54	12,00	0,20	0,50	2,0°	4890	330,0	120
AMK 6 .. L61	12,00	0,20	0,50	2,0°	4890	330,0	120

soffietto metallico:

in lega di rame e zinco CuZn20

mozzi: lega leggera AlCuMgP

fori mozzi:

combinazione di Ø standard, cfr. tabella pag. 4, finiti toll. G7

serie speciali: a richiesta, costruzione interamente in acciaio inox

esempio sigla: tipo AMK 1,2 - foro D1 Ø 6,35 mm - foro D2 Ø 8 mm, lunghezza totale 29 mm

--> **AMK 1,2-6,35-8 L29**

metallic bellows:

copper-zinc alloy CuZn20

hubs: light alloy AlCuMgP

hub bores:

combination of standard Ø, see. pag. 4, finished tol. G7

customer series: on request, stainless construction, welded hubs

part numbers: type AMK 1,2, bore D1 Ø 6,35 mm, bore D2 8 mm, overall length 29 mm

--> **AMK 1,2-6,35-8 L29**

soufflet metallique:

alliage cuivre-zinc CuZn20

moyeux: alliage léger AlCuMgP

alésage des moyeux:

combinaison de Ø standard, voir pag. 4, finis tol. G7

series speciales: sur demande, construction inoxydabile, moyeux soudés

exemple de commande: type AMK 1,25, alésage D1 Ø 6,35 mm, alésage D2 8 mm, longueur total 29 mm

--> **AMK 1,2-6,35-8 L29**

RODOFLEX

FLEXIBLE COUPLINGS - TORSIONALLY STIFF

**GIUNTO FLESSIBILE
TORSIONALMENTE RIGIDI
PER ENCODER**

**FLEXIBLE COUPLINGS
TORSIONALLY STIFF
FOR ENCODERS**

**JOINT D'ACCOUPEMENT
RIGIDITE A LA TORSION
POUR CODEURS**

AMKN..

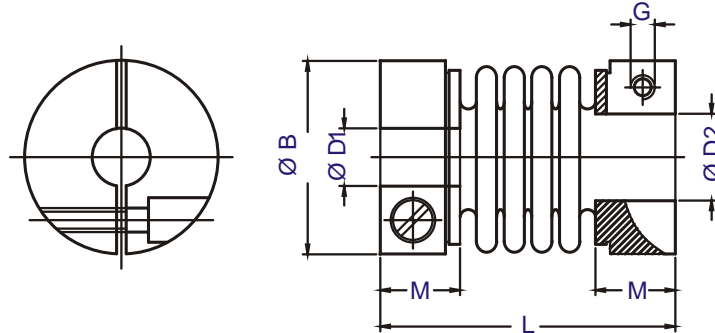

TIPO TYPE TYPE	Ø D ¹ - D ² MIN MAX mm	Ø B mm	L mm	M mm	G
AMKN 15 .. L24	3 => 6,35	15	24	7,5	M2
AMKN 15 .. L29	3 => 6,35	15	29	7,5	M2
AMKN 153 .. L29	3 => 6,35	15	29	7,5	M2
AMKN 20 .. L31	5 => 10	20	31	9,5	M2,5
AMKN 25 .. L32	5 => 12,7	24,5	32	12,5	M3
AMKN 25 .. L41	5 => 12,7	24,5	41	12,5	M3
AMKN 253 .. L41	5 => 12,7	24,5	41	12,5	M3
AMKN 30 .. L34	5 => 14	30	34	12	M3
AMKN 30 .. L40	5 => 14	30	40	12	M3
AMKN 40 .. L54	6 => 20	40	54	16,5	M5
AMKN 40 .. L61	6 => 20	40	61	16,5	M5
AMKN 403 .. L54	6 => 20	40	54	16,5	M5
AMKN 403 .. L61	6 => 20	40	61	16,5	M5

Ø FORI STANDARD

Ø ALESAGES STANDARD

STANDARD Ø BORES

TIPO/TYPE	3	3,2 1/8"	4	5	6	6,35 1/4"	7	8	9	9,52 3/8"	10	11	12	12,7 1/2"	14	
AMKN 15 .. L24	3	3,2	4	5	6	6,35										
AMKN 15 .. L29	3	3,2	4	5	6	6,35										
AMKN 153 .. L29	3	3,2	4	5	6	6,35										
AMKN 20 .. L31				5	6	6,35	7	8	9	9,52	10					
AMKN 25 .. L32				5	6	6,35	7	8	9	9,52	10	11	12	12,7		
AMKN 25 .. L41				5	6	6,35	7	8	9	9,52	10	11	12	12,7		
AMKN 253 .. L41				5	6	6,35	7	8	9	9,52	10	11	12	12,7		
AMKN 30 .. L34				5	6	6,35	7	8	9	9,52	10	11	12	12,7	14	
AMKN 30 .. L40				5	6	6,35	7	8	9	9,52	10	11	12	12,7	14	
TIPO/TYPE	6	6,35 1/4"	7	8	9	9,52 3/8"	10	11	12	12,7 1/2"	14	15	16	18	19	20
AMKN 40 .. L54	6	6,35	7	8	9	9,52	10	11	12	12,7	14	15	16	18	19	20
AMKN 40 .. L61	6	6,35	7	8	9	9,52	10	11	12	12,7	14	15	16	18	19	20
AMKN 403 .. L54	6	6,35	7	8	9	9,52	10	11	12	12,7	14	15	16	18	19	20
AMKN 403 .. L61	6	6,35	7	8	9	9,52	10	11	12	12,7	14	15	16	18	19	20

GIUNTO FLESSIBILE TORSIONALMENTE RIGIDI PER ENCODER

- ① COPPIA NOMINALE
- ② DISALLINEAMENTO PARALLELO
- ③ DISALLINEAMENTO IN DISTANZA
- ④ DISALLINEAMENTO ANGOLARE
- ⑤ RIGIDITA' TORSIONALE
- ⑥ MOMENTO D'INERZIA
- ⑦ MOMENTO SERRAGGIO VITI

FLEXIBLE COUPLINGS TORSIONALLY STIFF FOR ENCODERS

- ① NOMINAL TORQUE
- ② PARALLEL MISALIGNMENT
- ③ AXIAL DISPLACEMENT
- ④ ANGULAR MISALIGNMENT
- ⑤ TORSIONAL STIFFNESS
- ⑥ MOMENT OF INERTIA
- ⑦ SCREW TIGHTENING TORQUE

JOINT D'ACCOUPEMENT RIGIDITE A LA TORSION POUR CODEURS

- ① COUPLE NOMINAL
- ② MESALIGNEMENT PARALLEL
- ③ DEPLACEMENT AXIAL
- ④ MESALIGNEMENT ANGULAIRE
- ⑤ RIGIDITE' EN TORSION
- ⑥ MOMENT D'INERTIE
- ⑦ MOMENT SERRAGE DES VIS

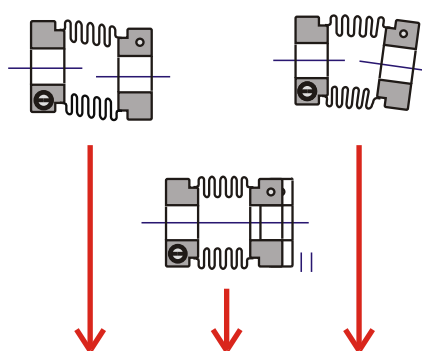

TIPO TYPE TYPE	① Nm	② PARALL. mm	③ DIST. mm	④ ANG. α°	⑤ Nm/rad	⑥ gcm ²	 g
AMKN 15 .. L24	0,40	0,10	0,25	1,5°	122	2,0	8
AMKN 15 .. L29	0,40	0,10	0,25	1,5°	122	2,0	8
AMKN 153 .. L29	0,90	0,10	0,25	0,5°	285	4,0	12
AMKN 20 .. L31	1,10	0,10	0,25	1,0°	257	7,0	16
AMKN 25 .. L32	2,00	0,15	0,30	1,0°	615	25,0	26
AMKN 25 .. L41	2,00	0,15	0,30	1,0°	615	25,0	26
AMKN 253 .. L41	4,00	0,10	0,30	1,0°	1170	36,0	38
AMKN 30 .. L34	3,00	0,20	0,40	1,0°	980	49,0	30
AMKN 30 .. L40	3,00	0,20	0,40	1,0°	980	49,0	30
AMKN 40 .. L54	7,00	0,25	0,60	2,0°	2910	272,0	100
AMKN 40 .. L61	7,00	0,25	0,60	2,0°	2910	272,0	100
AMKN 403 .. L54	12,00	0,20	0,50	2,0°	4890	330,0	120
AMKN 403 .. L61	12,00	0,20	0,50	2,0°	4890	330,0	120

soffietto metallico:

in lega di rame e zinco CuZn20

mozzi: lega leggera AlCuMgP

fori mozzi:

combinazione di Ø standard, cfr. tabella pag. 6, finiti toll. G7

serie speciali: a richiesta, costruzione inox, mozzi saldati

esempio sigla: tipo AMKN 25, foro D1 Ø 6,35 mm, foro D2 8 mm, lunghezza totale 41 mm

--> **AMKN 25-6,35-8 L41**

metallic bellows:

copper-zinc alloy CuZn20

hubs: light alloy AlCuMgP

hub bores:

combination of standard Ø, see. pag. 6, finished tol. G7

customer series: on request, stainless construction, welded hubs

part numbers: type AMKN 25, bore D1 Ø 6,35 mm, bore D2 8 mm, overall length 41 mm

--> **AMKN 25-6,35-8 L41**

soufflet metallique:

alliage cuivre-zinc CuZn20

moyeux: alliage léger AlCuMgP

alésage des moyeux:

combinaison de Ø standard, voir pag. 6, finis tol. G7

series speciales: sur demande, construction inoxydabile, moyeux soudés

exemple de commande: type AMKN 25, alésage D1 Ø 6,35 mm, alésage D2 8 mm, longueur total 41 mm

--> **AMKN 25-6,35-8 L41**

RODOFLEX

FLEXIBLE COUPLINGS - TORSIONALLY STIFF

GIUNTO FLESSIBILE
TORSIONALMENTE RIGIDI
TRASMISSIONE DI POTENZA

FLEXIBLE COUPLINGS
TORSIONALLY STIFF
POWER TRANSMISSION

JOINT D'ACCOUPEMENT
RIGIDITE A LA TORSION
TRANSMISSION DE PUISSANCE

ATMK..

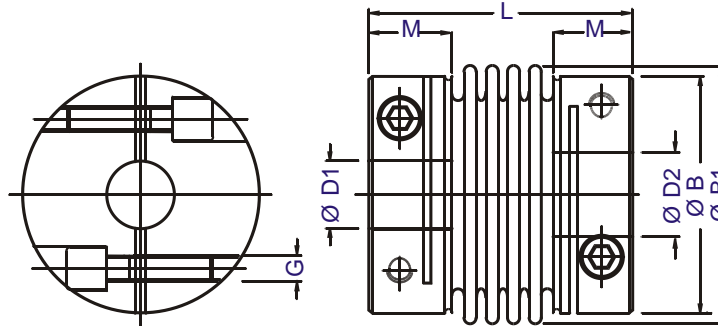

TIPO TYPE TYPE	$\varnothing D^1 - D^2$ MIN MAX mm	$\varnothing B$ mm	$\varnothing B1$ mm	L mm	M mm	G
ATMK 12 .. L48	8 => 15	30	32	48	17	M5
ATMK 16 .. L50	8 => 20	37,5	39,5	50	16	M5
ATMK 15 .. L71	12,7 => 30	51,5	56	71	19,5	M6
ATMK 20 .. L71	12,7 => 30	51,5	56	71	19,5	M6
ATMK 30 .. L77	14 => 32	58	66	77	22,5	M8
ATMK 30 .. L91	14 => 32	58	66	91	22,5	M8
ATMK 60 .. L77	14 => 32	58	66	77	22,5	M8
ATMK 60 .. L91	14 => 32	58	66	91	22,5	M8
ATMK 80 .. L84	18 => 40	72	82	84	26	M10
ATMK 80 .. L98	18 => 40	72	82	98	26	M10
ATMK 170 .. L84	18 => 40	72	82	84	26	M10
ATMK 170 .. L98	18 => 40	72	82	98	26	M10
ATMK 270 .. L92	30 => 60	93	101	92	30	M12
ATMK 320 .. L92	30 => 60	93	101	92	30	M12

Ø FORI STANDARD

Ø ALESAGES STANDARD

STANDARD Ø BORES

TIPO/TYP	8	9	9,52 3/8"	10	11	12	12,7 1/2"	14	15	16	17	18	19	20	22	24	25	28	30	32
ATMK 12 .. L48	8	9	9,52	10	11	12	12,7	14	15											
ATMK 16 .. L50	8	9		10	11	12		14	15	16		18	19	20						
ATMK 15 .. L71							12,7	14		16	17	18	19	20	22	24	25	28	30	
ATMK 20 .. L71							12,7	14		16	17	18	19	20	22	24	25	28	30	
ATMK 30 .. L77								14	15	16	17	18	19	20	22	24	25	28	30	32
ATMK 30 .. L91								14	15	16	17	18	19	20	22	24	25	28	30	32
ATMK 60 .. L77								14	15	16	17	18	19	20	22	24	25	28	30	32
ATMK 60 .. L91								14	15	16	17	18	19	20	22	24	25	28	30	32
TIPO/TYP	18	19	20	22	24	25	28	30	32	35	36	38	40	42	46	48	50	55	60	
ATMK 80 .. L84	18	19	20	22	24	25	28	30	32	35	36	38	40							
ATMK 80 .. L98	18	19	20	22	24	25	28	30	32	35	36	38	40							
ATMK 170 .. L84	18	19	20	22	24	25	28	30	32	35	36	38	40							
ATMK 170 .. L98	18	19	20	22	24	25	28	30	32	35	36	38	40							
ATMK 270 .. L92								30	32	35	36	38	40	42	46	48	50	55	60	
ATMK 320 .. L92								30	32	35	36	38	40	42	46	48	50	55	60	

RODOFLEX

FLEXIBLE COUPLINGS - TORSIONALLY STIFF

GIUNTO FLESSIBILE
TORSIONALMENTE RIGIDI
TRASMISSIONE DI POTENZA

FLEXIBLE COUPLINGS
TORSIONALLY STIFF
POWER TRANSMISSION

JOINT D'ACCOUPEMENT
RIGIDITE A LA TORSION
TRANSMISSION DE PUISSANCE

- ① COPPIA NOMINALE
- ② DISALLINEAMENTO PARALLELO
- ③ DISALLINEAMENTO IN DISTANZA
- ④ DISALLINEAMENTO ANGOLARE
- ⑤ RIGIDITA' TORSIONALE
- ⑥ MOMENTO D'INERZIA
- ⑦ MOMENTO SERRAGGIO VITI

- ① NOMINAL TORQUE
- ② PARALLEL MISALIGNMENT
- ③ AXIAL DISPLACEMENT
- ④ ANGULAR MISALIGNMENT
- ⑤ TORSIONAL STIFFNESS
- ⑥ MOMENT OF INERTIA
- ⑦ SCREW TIGHTENING TORQUE

- ① COUPLE NOMINAL
- ② MESALIGNEMENT PARALLELE
- ③ DEPLACEMENT AXIAL
- ④ MESALIGNEMENT ANGULAIRE
- ⑤ RIGIDITE' EN TORSION
- ⑥ MOMENT D'INERTIE
- ⑦ MOMENT SERRAGE DES VIS

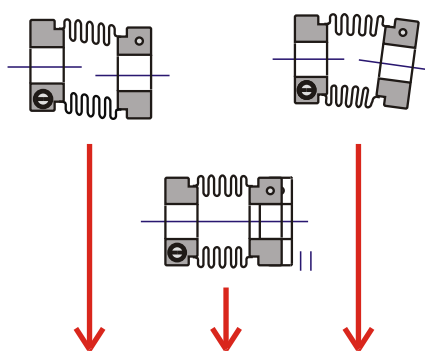

TIPO TYPE TYPE	① Nm	② PARALL. mm	③ DIST. mm	④ ANG. α°	⑤ 10 ³ Nm/rad	⑥ 10 ⁻³ kgm ²	⑦ Nm	 kg
ATMK 12 .. L48	12	0,12	0,25	1,0°	9	0,02	3,5	0,155
ATMK 16 .. L50	16	0,12	0,30	1,0°	11	0,05	3,5	0,235
ATMK 15 .. L71	10	0,15	0,30	1,0°	15	0,20	6	0,515
ATMK 20 .. L71	20	0,15	0,30	1,0°	28	0,22	6	0,535
ATMK 30 .. L77	30	0,15	0,30	1,0°	25	0,39	16	0,775
ATMK 30 .. L91	30	0,15	0,30	1,0°	25	0,40	16	0,785
ATMK 60 .. L77	60	0,15	0,30	1,0°	42	0,44	16	0,820
ATMK 60 .. L91	60	0,15	0,30	1,0°	42	0,45	16	0,835
ATMK 80 .. L84	80	0,20	0,35	1,5°	45	1,05	32	1,420
ATMK 80 .. L98	80	0,20	0,35	1,5°	45	1,07	32	1,430
ATMK 170 .. L84	170	0,20	0,35	1,5°	90	1,15	32	1,480
ATMK 170 .. L98	170	0,20	0,35	1,5°	90	1,19	32	1,505
ATMK 270 .. L92	270	0,20	0,50	2,0°	150	3,56	56	2,690
ATMK 320 .. L92	320	0,20	0,50	2,0°	190	4,26	56	2,780

soffietto metallico:

in acciaio inox 1.4541, saldato ai mozzi

metallic bellows:

stainless steel 1.4541, welded to hubs

soufflet metallique:

acier inoxydable 1.4541, soudé aux moyeux

mozzi: acciaio inox 1.4305

hubs: stainless steel 1.4305

moyeux: acier inoxydable 1.4305

fori mozzi:

combinazione di Ø standard, cfr. tabella pag. 8, finiti toll. G7

hub bores:

combination of standard Ø, see. pag. 8, finished tol. G7

alésage des moyeux:

combinaison de Ø standard, voir pag. 8, finis tol. G7

esempio sigla: tipo ATMK 30, foro D1 Ø 20 mm, foro D2 24 mm, lunghezza totale 91 mm

part numbers: type ATMK 30, bore D1 Ø 20 mm, bore D2 24 mm, overall length 91 mm

exemple de commande: type ATMK 30, alésage D1 Ø 20 mm, alésage D2 24 mm, longueur total 91 mm

--> **ATMK 30-20-24 L91**

--> **ATMK 30-20-24 L91**

--> **ATMK 30-20-24 L91**

RODOFLEX

FLEXIBLE COUPLINGS - TORSIONALLY STIFF

GIUNTO FLESSIBILE
TORSIONALMENTE RIGIDI
TRASMISSIONE DI POTENZA

FLEXIBLE COUPLINGS
TORSIONALLY STIFF
POWER TRANSMISSION

JOINT D'ACCOUPEMENT
RIGIDITE A LA TORSION
TRANSMISSION DE PUISSANCE

ATMN..

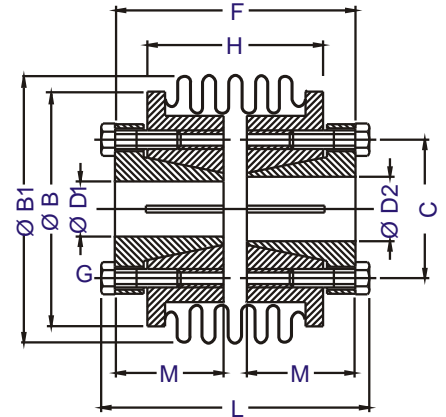
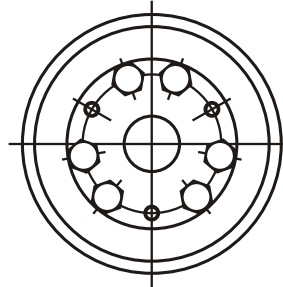

TIPO TYPE TYPE	Ø D ¹ - D ² MIN MAX mm	Ø B mm	Ø B1 mm	L mm	M mm	C	F mm	H mm	G
ATMN 15 .. L58	8 => 19	51,5	56	57,6	23,5	30	52	41	M4
ATMN 20 .. L58	8 => 19	51,5	56	57,6	23,5	30	52	41	M4
ATMN 30 .. L74	14 => 22	58	66	74	28	36	66	50	M6
ATMN 30 .. L88	14 => 22	58	66	88	28	36	80	64	M6
ATMN 60 .. L74	14 => 22	58	66	74	28	36	66	50	M6
ATMN 60 .. L88	14 => 22	58	66	88	28	36	80	64	M6
ATMN 80 .. L76	18 => 35	72	82	76	29	50	68	50	M6
ATMN 80 .. L90	18 => 35	72	82	90	29	50	82	64	M6
ATMN 170 .. L76	18 => 35	72	82	76	29	50	68	50	M6
ATMN 170 .. L90	18 => 35	72	82	90	29	50	82	64	M6
ATMN 270 .. L87	26 => 41	93	101	87	36	62	76	52	M8
ATMN 320 .. L87	26 => 41	93	101	87	36	62	76	52	M8

Ø FORI STANDARD

Ø ALESAGES STANDARD

STANDARD Ø BORES

TIPO/TYP	8	9	9,52 3/8"	10	11	12	12,7 1/2"	14	15	16	17	18	19	20	22
ATMN 15 .. L58	8	9	9,52	10	11	12	12,7	14	15	16	17	18	19		
ATMN 20 .. L58	8	9	9,52	10	11	12	12,7	14	15	16	17	18	19		
ATMN 30 .. L74								14	15	16	17	18	19	20	22
ATMN 30 .. L88								14	15	16	17	18	19	20	22
ATMN 60 .. L74								14	15	16	17	18	19	20	22
ATMN 60 .. L88								14	15	16	17	18	19	20	22
TIPO/TYP	18	19	20	22	24	25	26	28	30	32	35	38	40	41	
ATMN 80 .. L76	18	19	20	22	24	25	26	28	30	32	35				
ATMN 80 .. L90	18	19	20	22	24	25	26	28	30	32	35				
ATMN 170 .. L76	18	19	20	22	24	25	26	28	30	32	35				
ATMN 170 .. L90	18	19	20	22	24	25	26	28	30	32	35				
ATMN 270 .. L87							26	28	30	32	35	38	40	41	
ATMN 320 .. L87							26	28	30	32	35	38	40	41	

GIUNTO FLESSIBILE
TORSIONALMENTE RIGIDI
TRASMISSIONE DI POTENZA

FLEXIBLE COUPLINGS
TORSIONALLY STIFF
POWER TRANSMISSION

JOINT D'ACCOUPEMENT
RIGIDITE A LA TORSION
TRANSMISSION DE PUISSANCE

- ① COPPIA NOMINALE
- ② DISALLINEAMENTO PARALLELO
- ③ DISALLINEAMENTO IN DISTANZA
- ④ DISALLINEAMENTO ANGOLARE
- ⑤ RIGIDITA' TORSIONALE
- ⑥ MOMENTO D'INERZIA
- ⑦ MOMENTO SERRAGGIO VITI

- ① NOMINAL TORQUE
- ② PARALLEL MISALIGNMENT
- ③ AXIAL DISPLACEMENT
- ④ ANGULAR MISALIGNMENT
- ⑤ TORSIONAL STIFFNESS
- ⑥ MOMENT OF INERTIA
- ⑦ SCREW TIGHTENING TORQUE

- ① COUPLE NOMINAL
- ② MESALIGNEMENT PARALLEL
- ③ DEPLACEMENT AXIAL
- ④ MESALIGNEMENT ANGULAIRE
- ⑤ RIGIDITE' EN TORSION
- ⑥ MOMENT D'INERTIE
- ⑦ MOMENT SERRAGE DES VIS

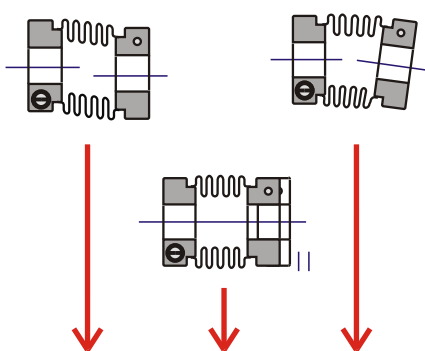

TIPO TYPE TYPE	① Nm	② PARALL. mm	③ DIST. mm	④ ANG. α°	⑤ 10 ³ Nm/rad	⑥ 10 ⁻³ kgm ²	⑦ Nm	 kg
ATMN 15 .. L58	10	0,15	0,30	1,0°	15	0,13	4	0,440
ATMN 20 .. L58	20	0,15	0,30	1,0°	28	0,14	4	0,460
ATMN 30 .. L74	30	0,15	0,30	1,0°	25	0,34	12	0,760
ATMN 30 .. L88	30	0,15	0,30	1,0°	25	0,37	12	0,805
ATMN 60 .. L74	60	0,15	0,30	1,0°	42	0,37	12	0,805
ATMN 60 .. L88	60	0,15	0,30	1,0°	42	0,42	12	0,855
ATMN 80 .. L76	80	0,20	0,35	1,5°	45	0,88	12	1,310
ATMN 80 .. L90	80	0,20	0,35	1,5°	45	0,90	12	1,340
ATMN 170 .. L76	170	0,20	0,35	1,5°	90	0,98	12	1,370
ATMN 170 .. L90	170	0,20	0,35	1,5°	90	1,02	12	1,415
ATMN 270 .. L87	270	0,20	0,50	2,0°	150	2,65	30	2,560
ATMN 320 .. L87	320	0,20	0,50	2,0°	190	2,88	30	2,670

soffietto metallico:
in acciaio inox 1.4541, saldato ai mozzi

mozzi: acciaio inox 1.4305, boccola
acciaio 1.7227

fori mozzi:
combinazione di Ø standard, cfr. tabella
pag. 10, finiti toll. G7

esempio sigla: tipo ATMN 80, foro D1
Ø 20 mm, foro D2 24 mm, lunghezza
totale 90 mm

--> **ATMN 80-20-24 L90**

metallic bellows:
stainless steel 1.4541, welded to hubs

hubs: stainless steel 1.4305, conical
sleeve steel 1.7227

hub bores:
combination of standard Ø, see pag.
10, finished tol. G7

part numbers: type ATMN 80, bore D1
Ø 20 mm, bore D2 24 mm, overall
length 90 mm

--> **ATMN 80-20-24 L90**

soufflet metallique:
àcier inoxydable 1.4541, soudé aux
moyeux

moyeux: àcier inoxydable 1.4305,
bague conique àcier 1.7227

alésage des moyeux:
combinaison de Ø standard, voir pag.
10, finis tol. G7

exemple de commande: type ATMN
80, alésage D1 Ø 20 mm, alésage D2
24 mm, longueur total 90 mm

--> **ATMN 80-20-24 L90**

RODOFLEX

FLEXIBLE COUPLINGS - TORSIONALLY STIFF

GIUNTO FLESSIBILE
TORSIONALMENTE RIGIDI
TRASMISSIONE DI POTENZA

FLEXIBLE COUPLINGS
TORSIONALLY STIFF
POWER TRANSMISSION

JOINT D'ACCOUPEMENT
RIGIDITE A LA TORSION
TRANSMISSION DE PUISSANCE

ATMF..

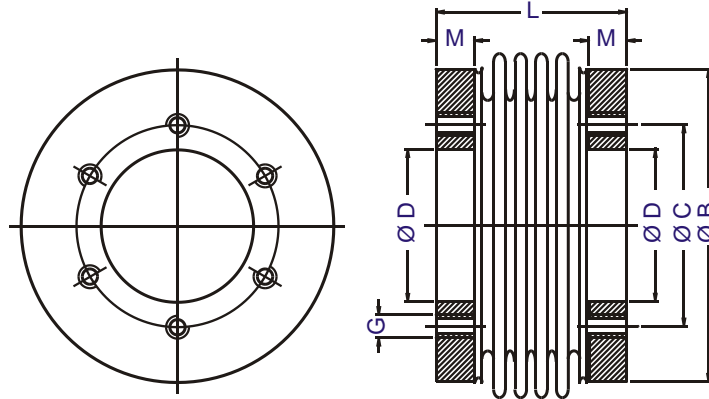

TIPO TYPE TYPE	Ø D mm	Ø B mm	L mm	C mm	M mm	G
ATMF 1 .. L41	25	56	41	32	8	M4
ATMF 2 .. L41	25	56	41	32	8	M4
ATMF 3 .. L42	28	66	42	38	10	M6
ATMF 3 .. L56	28	66	56	38	10	M6
ATMF 6 .. L42	28	66	42	38	10	M6
ATMF 6 .. L56	28	66	56	38	10	M6
ATMF 8 .. L42	40	82	42	53	10	M6
ATMF 8 .. L56	40	82	56	53	10	M6
ATMF 17 .. L42	40	82	42	53	10	M6
ATMF 17 .. L56	40	82	56	53	10	M6
ATMF 27 .. L44	50	101	44	65	14	M8
ATMF 32 .. L44	50	101	44	65	14	M8

Ø FORI STANDARD

Ø ALESAGES STANDARD

STANDARD Ø BORES

TIPO/TYPE	25	28	40	50
ATMF 1 .. L41	25			
ATMF 2 .. L41	25			
ATMF 3 .. L42		28		
ATMF 3 .. L56		28		
ATMF 6 .. L42		28		
ATMF 6 .. L56		28		
ATMF 8 .. L42			40	
ATMF 8 .. L56			40	
ATMF 17 .. L42			40	
ATMF 17 .. L56			40	
ATMF 27 .. L44				50
ATMF 32 .. L44				50

GIUNTO FLESSIBILE TORSIONALMENTE RIGIDI TRASMISSIONE DI POTENZA

FLEXIBLE COUPLINGS TORSIONALLY STIFF POWER TRANSMISSION

JOINT D'ACCOUPEMENT RIGIDITE A LA TORSION TRANSMISSION DE PUISSANCE

- ① COPPIA NOMINALE
- ② DISALLINEAMENTO PARALLELO
- ③ DISALLINEAMENTO IN DISTANZA
- ④ DISALLINEAMENTO ANGOLARE
- ⑤ RIGIDITA' TORSIONALE
- ⑥ MOMENTO D'INERZIA
- ⑦ MOMENTO SERRAGGIO VITI

- ① NOMINAL TORQUE
- ② PARALLEL MISALIGNMENT
- ③ AXIAL DISPLACEMENT
- ④ ANGULAR MISALIGNMENT
- ⑤ TORSIONAL STIFFNESS
- ⑥ MOMENT OF INERTIA
- ⑦ SCREW TIGHTENING TORQUE

- ① COUPLE NOMINAL
- ② MESALIGNEMENT PARALLEL
- ③ DEPLACEMENT AXIAL
- ④ MESALIGNEMENT ANGULAIRE
- ⑤ RIGIDITE' EN TORSION
- ⑥ MOMENT D'INERTIE
- ⑦ MOMENT SERRAGE DES VIS

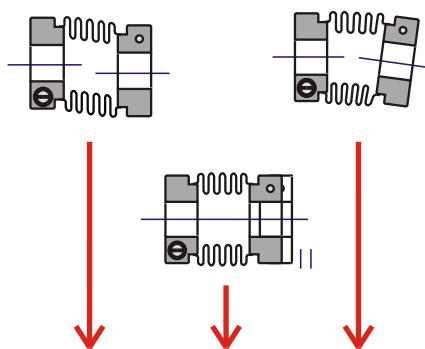

TIPO TYPE TYPE	① Nm	② PARALL. mm	③ DIST. mm	④ ANG. α°	⑤ 10 ³ Nm/rad	⑥ 10 ⁻³ kgm ²	 kg
ATMF 1 .. L41	10	0,15	0,30	1,0°	15	0,08	0,170
ATMF 2 .. L41	20	0,15	0,30	1,0°	28	0,09	0,190
ATMF 3 .. L42	30	0,15	0,30	1,0°	25	0,16	0,285
ATMF 3 .. L56	30	0,15	0,30	1,0°	25	0,19	0,305
ATMF 6 .. L42	60	0,15	0,30	1,0°	42	0,20	0,310
ATMF 6 .. L56	60	0,15	0,30	1,0°	42	0,24	0,360
ATMF 8 .. L42	80	0,20	0,35	1,5°	45	0,38	0,415
ATMF 8 .. L56	80	0,20	0,35	1,5°	45	0,40	0,430
ATMF 17 .. L42	170	0,20	0,35	1,5°	90	0,48	0,475
ATMF 17 .. L56	170	0,20	0,35	1,5°	90	0,52	0,495
ATMF 27 .. L44	270	0,20	0,50	2,0°	150	1,20	0,865
ATMF 32 .. L44	320	0,20	0,50	2,0°	190	1,42	0,950

soffietto metallico:
in acciaio inox 1.4541, saldato ai mozzi

metallic bellows:
stainless steel 1.4541, welded to hubs

soufflet metallique:
àacier inoxydable 1.4541

mozzi:
acciaio inox 1.4305

hubs:
stainless steel 1.4305

moyeux:
àacier inoxydable 1.4305

esempio sigla:
tipo ATMF 8, lunghezza totale 56 mm

part numbers:
type ATMF 8, overall length 56 mm

exemple de commande:
type ATMF 8, longueur total 56 mm

--> **ATMF 8 L56**

--> **ATMF 8 L56**

--> **ATMF 8 L56**

RODOFLEX

FLEXIBLE COUPLINGS - TORSIONALLY STIFF

GIUNTO FLESSIBILE
TORSIONALMENTE RIGIDI
TRASMISSIONE DI POTENZA

FLEXIBLE COUPLINGS
TORSIONALLY STIFF
POWER TRANSMISSION

JOINT D'ACCOUPEMENT
RIGIDITE A LA TORSION
TRANSMISSION DE PUISSANCE

ATMB..

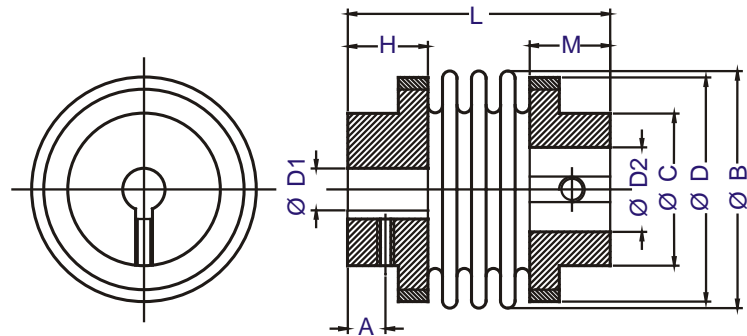

TIPO TYPE TYPE	$\varnothing D^1 - D^2$ MIN MAX mm	$\varnothing B$ mm	$\varnothing B^1$ mm	L mm	M mm	C mm	H mm	A mm
ATMB 56 .. L65	10 => 20	51,5	56	65	16,5	36	12	6
ATMB 66 .. L72	10 => 25	58	66	72	20	45	15	7,5
ATMB 66 .. L86	10 => 25	58	66	86	20	45	15	7,5
ATMB 82 .. L82	20 => 28	72	82	82	25	55	20	12
ATMB 82 .. L96	20 => 28	72	82	96	25	55	20	12
ATMB 101 .. L88	24 => 42	93	101	88	28	70	20	12

\varnothing FORI STANDARD

\varnothing ALESAGES STANDARD

STANDARD \varnothing BORES

TIPO/TYP	10	11	12	14	15	16	18	19	20	22	24	25	28	30	32	40	42
ATMB 56 .. L65	10	11	12	14	15	16	18	19	20								
ATMB 66 .. L72	10			14	15	16	18	19	20	22	24	25					
ATMB 66 .. L86	10			14	15	16	18	19	20	22	24	25					
ATMB 82 .. L82									20	22	24	25	28				
ATMB 82 .. L96									20	22	24	25	28				
ATMB 101 .. L88											24		28	30	32	40	42

GIUNTO FLESSIBILE TORSIONALMENTE RIGIDI TRASMISSIONE DI POTENZA

- ① COPPIA NOMINALE
- ② DISALLINEAMENTO PARALLELO
- ③ DISALLINEAMENTO IN DISTANZA
- ④ DISALLINEAMENTO ANGOLARE
- ⑤ RIGIDITA' TORSIONALE
- ⑥ MOMENTO D'INERZIA
- ⑦ MOMENTO SERRAGGIO VITI

FLEXIBLE COUPLINGS TORSIONALLY STIFF POWER TRANSMISSION

- ① NOMINAL TORQUE
- ② PARALLEL MISALIGNMENT
- ③ AXIAL DISPLACEMENT
- ④ ANGULAR MISALIGNMENT
- ⑤ TORSIONAL STIFFNESS
- ⑥ MOMENT OF INERTIA
- ⑦ SCREW TIGHTENING TORQUE

JOINT D'ACCOUPEMENT RIGIDITE A LA TORSION TRANSMISSION DE PUISSANCE

- ① COUPLE NOMINAL
- ② MESALIGNEMENT PARALLEL
- ③ DEPLACEMENT AXIAL
- ④ MESALIGNEMENT ANGULAIRE
- ⑤ RIGIDITE' EN TORSION
- ⑥ MOMENT D'INERTIE
- ⑦ MOMENT SERRAGE DES VIS

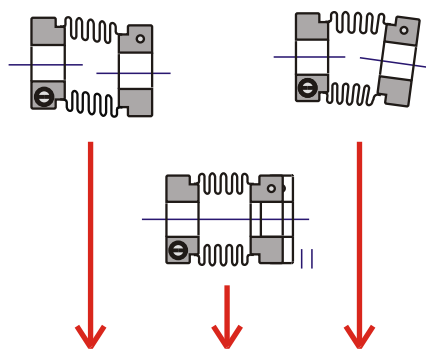

TIPO TYPE TYPE	① Nm	② PARALL. mm	③ DIST. mm	④ ANG. α°	⑤ 10 ³ Nm/rad	⑥ 10 ⁻³ kgm ²	 kg
ATMB 56 .. L65	20	0,15	0,30	1,0°	28	0,12	0,365
ATMB 66 .. L72	60	0,15	0,30	1,0°	42	0,26	0,610
ATMB 66 .. L86	60	0,15	0,30	1,0°	42	0,31	0,660
ATMB 82 .. L82	170	0,20	0,35	1,5°	90	0,69	1,070
ATMB 82 .. L96	170	0,20	0,35	1,5°	90	0,73	1,095
ATMB 101 .. L88	320	0,20	0,50	2,0°	190	2,12	2,055

soffietto metallico:

in acciaio inox 1.4541, saldato ai mozzi

mozzi: acciaio inox 1.4305

fori mozzi:

combinazione di Ø standard, cfr. tabella pag. 14, finiti toll. G7

cava:

a norma DIN 6885, tolleranza P9

esempio sigla: tipo ATMB 66, foro D1 Ø 19 mm, foro D2 20 mm, lunghezza totale 86 mm

--> **ATMB 66-19-20 L86**

metallic bellows:

stainless steel 1.4541, welded to hubs

hubs: stainless steel 1.4305

hub bores:

combination of standard Ø, see pag. 14, finished tol. G7

keyway:

DIN 6885 specifications, tolerance P9

part numbers: type ATMB 66, bore D1 Ø 19 mm, bore D2 20 mm, overall length 86 mm

--> **ATMB 66-19-20 L86**

soufflet metallique:

àcier inoxydable 1.4541, soudé aux moyeux

moyeux: àcier inoxydable 1.4305

alésage des moyeux:

combinaison de Ø standard, voir pag. 14, finis tol. G7

rainure:

à norme DIN 6885, tolérance P9

exemple de commande: type ATMB 66, alésage D1 Ø 19 mm, alésage D2 20 mm, longueur total 86 mm

--> **ATMB 66-19-20 L86**

RODOFLEX

FLEXIBLE COUPLINGS - TORSIONALLY STIFF

GIUNTO FLESSIBILE
TORSIONALMENTE RIGIDI
PER ENCODER
CORPO IN POLIAMMIDE
FORI GREZZI

AMKP 3 - MINIATURA

AMKP 5 - TAGLIA STANDARD

FLEXIBLE COUPLINGS
TORSIONALLY STIFF
FOR ENCODERS
POLYAMIDE BODY
COARSE HUBS

AMKP 3 - MINIATURE

AMKP 5 - STANDARD SIZE

JOINT D'ACCOUPEMENT
RIGIDITE A LA TORSION
POUR CODEURS
CORPS EN POLYAMIDE
MOYEUX NON FINI

AMKP 3 - MINIATURE

AMKP 5 - TAILLE STANDARD

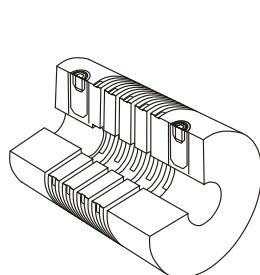

(SEZIONE - SECTION)

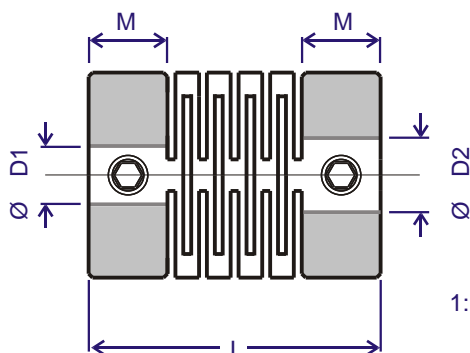

1:1 (AMKP 5)

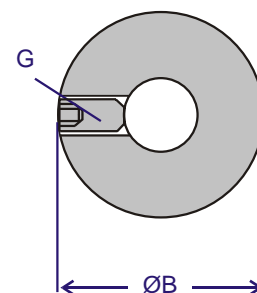

Ø B	L	M	G	D1	D2	D1/D2
mm	mm	mm		standard		max
12,7	22,0	6,9	M3	2,9	4	6,35
26,0	37,5	11,0	M5	5,9	7,5	12,7

coars e
grezzi
preforé

DIMENSIONS DIMENSIONI

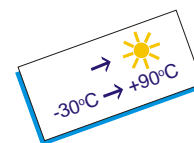

PERFORMANCE PRESTAZIONI

torque - coppia - couple			disallineamento		g
nominale	alternato	max	ang.	parall.	
Nm	Nm	Nm	°	mm	
0,25	0,13	0,5	5°	0,18	3,1
3,25	1,75	7,0	5°	0,3	23,5

funzione: giunto flessibile torsionalmente rigido per la compensazione di disallineamenti assiali tra alberi rotanti

caratteristiche: flessibilità assiale, esente da elasticità e gioco radiali

materiale: poliammide stampato PA 6.6 Verton RF/700/100 grigio o nero

foratura: forniti con *fori grezzi*; l'utilizzatore può alesare il foro fino al diametro richiesto (AMKP 3, max Ø 6,35 - AMKP 5 max. Ø 12,7 mm)

2 grani filettati in acciaio a testa cava esagonale M5 per bloccaggio alberi

task: flexible coupling, torsionally stiff, zero radial back-lash; used for compensating misalignment between rotating shafts

features: axial flexibility, no clearance, no radial backlash

material: moulded polyamide PA 6.6 Verton RF/700/100 gray or black

bores: supplied with *coarse hub bores*; end user can drill the hub up required diameter (AMKP 3, max Ø 6,35 mm - AMKP 5 max. Ø 12,7 mm)

2 steel setting hex-socket screws for shaft locking

emploi: joint d'accouplement pour la compensation du désalignement axial entre arbres en rotation

caractéristiques: flexibilité axiale, rigidité à la torsion, sans jeu radial

construction: polyamide injecté PA 6.6 Verton RF/700/100 gris ou noir

perçage: les joints sont livrés *pre-forés*; l'utilisateur peut aléser jusqu'au diamètre nécessaire (AMKP 3, max. Ø 6,35 mm - AMKP 5 max. Ø 12,7 mm)

2 vis à six pans M5 en acier pour le blocage des arbres

RODOFLEX

FLEXIBLE COUPLINGS - TORSIONALLY STIFF

AVVERTENZA DI MONTAGGIO

MOUNTING INSTRUCTION

AVIS DE MONTAGE

MANEGGIARE CON CURA!

Sia nella fase di montaggio, sia nell'esercizio non superare mai i valori di catalogo per **max. disallineamento angolare, parallelo e scostamento in distanza**

HANDLE WITH CARE!

Never exceed catalogue data for **angular, parallel and axial misplacement during handling and mounting nor while running**

MANIER AVEC SOIN!

Ne jamais dépasser les valeurs pour **désalignement angulaire et parallèle et déplacement axial pendant le montage et l'usage**

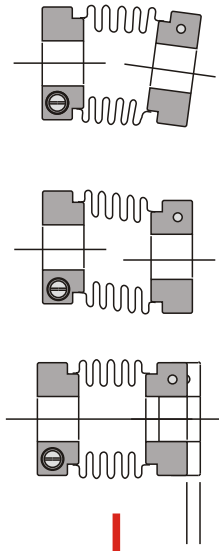

RISPETTATE I DATI DEL CATALOGO

RESPECT CATALOGUE DATA

RESPECTEZ LES DONNES DU CATALOGUE

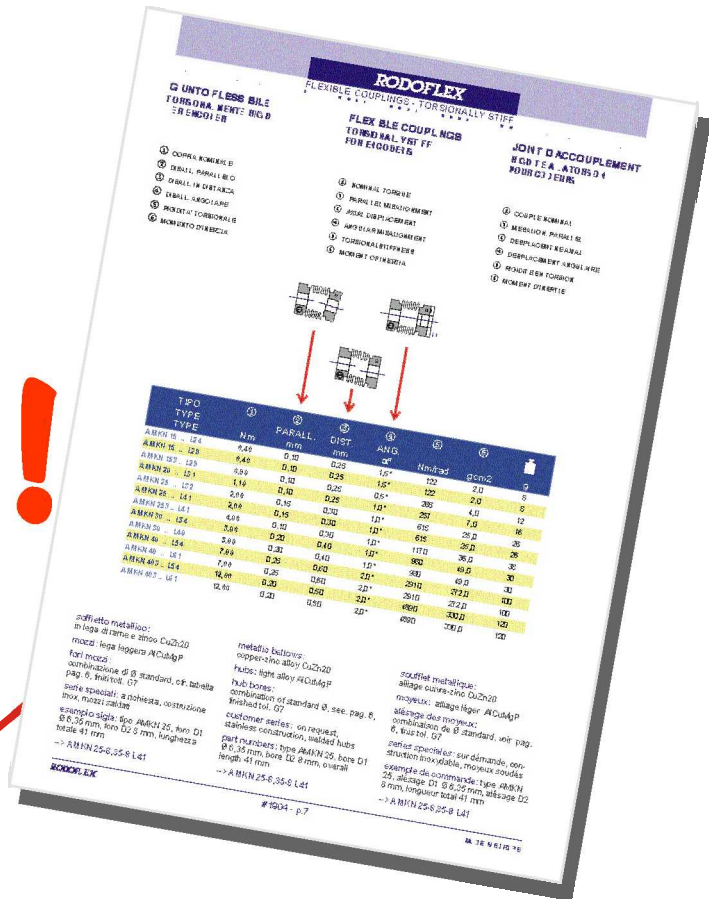

DISTRIBUZIONE INTERNAZIONALE GETECNO SRL - GENOVA. CATALOGO #1904, ANNULLA I PRECEDENTI.
IL PROGRAMMA RODOFLEX E' IN COSTANTE SVILUPPO, I DATI IN QUESTO CATALOGO SONO INDICATIVI E NON VINCOLANTI: CON RISERVA DI MODIFICA SENZA PREAVVISO.
RIPRODUZIONE VIETATA SENZA AUTORIZZAZIONE DI GETECNO SRL.

DISTRIBUTION GETECNO SRL - GENOVA, ITALY. CATALOGUE #1904, VOIDS ANY FORMER ISSUE.
RODOFLEX MANUFACTURING PROGRAMME SUBJECTED TO CONTINUAL IMPROVEMENT AND DEVELOPMENT, DATA SUBJECT TO CHANGE.
NO REPRODUCTION WITHOUT APPROVAL BY GETECNO SRL.

DISTRIBUTION GETECNO SRL - GENOVA, ITALIE. CATALOGUE #1904, ANNULLER LES PRECEDENTS.
PRODUCTION RODOFLEX SUJETTE A AMELIORATION COSTANTE, SOUS RESERVE DE MODIFICATION.
REPRODUCTION, MEME PARTIELLE, INTERDITE SAS AUTORISATION PAR GETECNO SRL.

RODOFLEX - MARCHIO DEPOSITATO.

RODOFLEX - REGISTERED TRADE MARK.

RODOFLEX - MARQUE ENREGISTREE

il nostro programma comprende:

our product range:

notre gamme de produits:

RODOSET



RODOGRIP



RODOFLEX



AURORA



RODOBAL

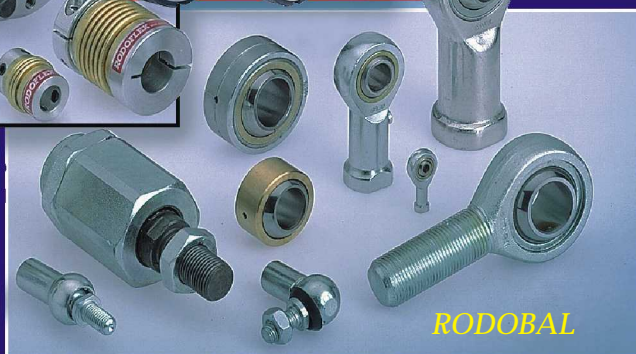

il vostro fornitore:

your supplier:

votre fournisseurs:

www.rodoflex.com

International master distributor:

Getecno srl
I - 16141 GENOVA - Italy

internet: www.getecno.com
e-mail: info@getecno.com

phone +39 010 835.60.16
fax +39 010 835.66.55